

Vertical tube : \varnothing 42 x 1,35 mm
 Horizontal tube : \varnothing 30 x 1,35 mm
 Horizontal wire : 3,5x \varnothing 4,0 mm
 Material : 8x \varnothing 4,0 mm
 Finish : Galvanized
 Weight : 13 KG

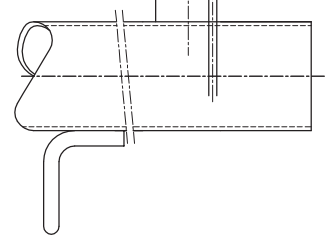
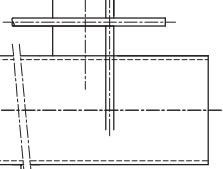
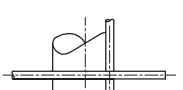
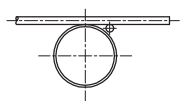
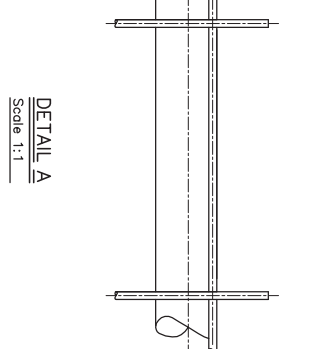
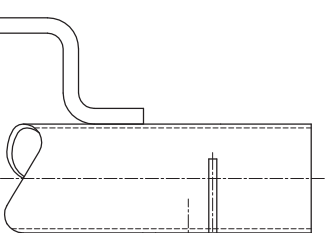
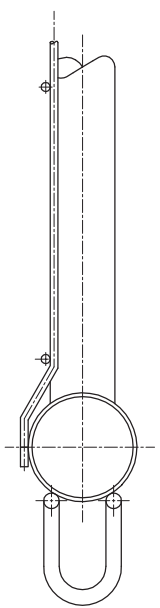
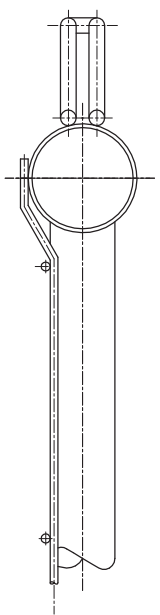
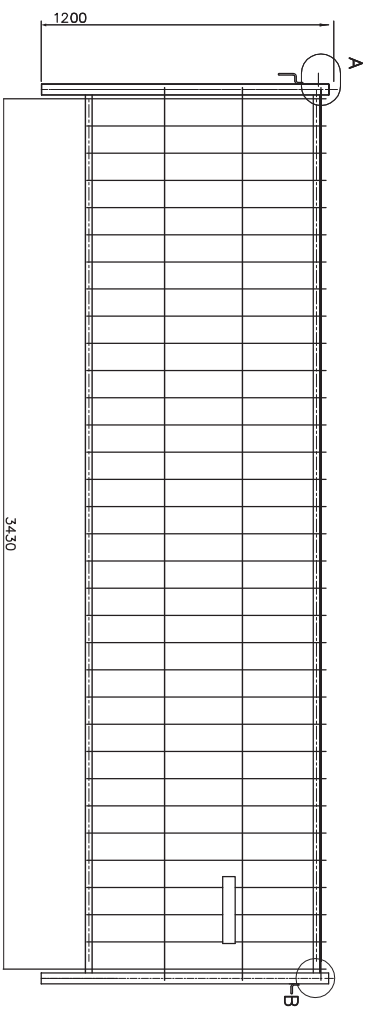

DETAIL A
Scale 1:1

DETAIL B
Scale 1:1

no.	description	date	project	sheet	total	revision
1	1:10	02/10/10				
2	1:10	02/10/10				
3	1:10	02/10/10				
4	1:10	02/10/10				
5	1:10	02/10/10				
6	1:10	02/10/10				
7	1:10	02/10/10				
8	1:10	02/10/10				
9	1:10	02/10/10				
10	1:10	02/10/10				
11	1:10	02/10/10				
12	1:10	02/10/10				
13	1:10	02/10/10				
14	1:10	02/10/10				
15	1:10	02/10/10				
16	1:10	02/10/10				
17	1:10	02/10/10				
18	1:10	02/10/10				
19	1:10	02/10/10				
20	1:10	02/10/10				
21	1:10	02/10/10				
22	1:10	02/10/10				
23	1:10	02/10/10				
24	1:10	02/10/10				
25	1:10	02/10/10				
26	1:10	02/10/10				
27	1:10	02/10/10				
28	1:10	02/10/10				
29	1:10	02/10/10				
30	1:10	02/10/10				
31	1:10	02/10/10				
32	1:10	02/10/10				
33	1:10	02/10/10				
34	1:10	02/10/10				
35	1:10	02/10/10				
36	1:10	02/10/10				
37	1:10	02/10/10				
38	1:10	02/10/10				
39	1:10	02/10/10				
40	1:10	02/10/10				
41	1:10	02/10/10				
42	1:10	02/10/10				
43	1:10	02/10/10				
44	1:10	02/10/10				
45	1:10	02/10/10				
46	1:10	02/10/10				
47	1:10	02/10/10				
48	1:10	02/10/10				
49	1:10	02/10/10				
50	1:10	02/10/10				
51	1:10	02/10/10				
52	1:10	02/10/10				
53	1:10	02/10/10				
54	1:10	02/10/10				
55	1:10	02/10/10				
56	1:10	02/10/10				
57	1:10	02/10/10				
58	1:10	02/10/10				
59	1:10	02/10/10				
60	1:10	02/10/10				
61	1:10	02/10/10				
62	1:10	02/10/10				
63	1:10	02/10/10				
64	1:10	02/10/10				
65	1:10	02/10/10				
66	1:10	02/10/10				
67	1:10	02/10/10				
68	1:10	02/10/10				
69	1:10	02/10/10				
70	1:10	02/10/10				
71	1:10	02/10/10				
72	1:10	02/10/10				
73	1:10	02/10/10				
74	1:10	02/10/10				
75	1:10	02/10/10				
76	1:10	02/10/10				
77	1:10	02/10/10				
78	1:10	02/10/10				
79	1:10	02/10/10				
80	1:10	02/10/10				
81	1:10	02/10/10				
82	1:10	02/10/10				
83	1:10	02/10/10				
84	1:10	02/10/10				
85	1:10	02/10/10				
86	1:10	02/10/10				
87	1:10	02/10/10				
88	1:10	02/10/10				
89	1:10	02/10/10				
90	1:10	02/10/10				
91	1:10	02/10/10				
92	1:10	02/10/10				
93	1:10	02/10/10				
94	1:10	02/10/10				
95	1:10	02/10/10				
96	1:10	02/10/10				
97	1:10	02/10/10				
98	1:10	02/10/10				
99	1:10	02/10/10				
100	1:10	02/10/10				

HERAS MOBILE FENCING & SECURITY

MDOO HOOK & EYE

138 / 0

HERAS MOBILE FENCING & SECURITY