

60 Freiraum /
clearance

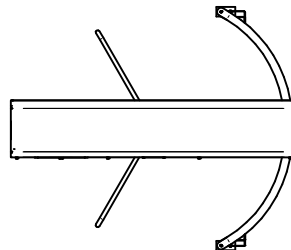
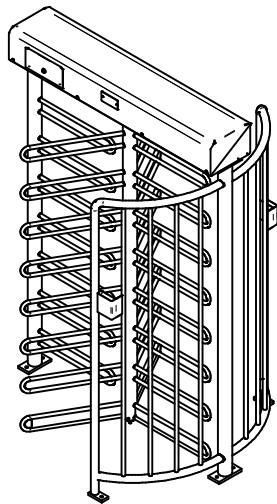
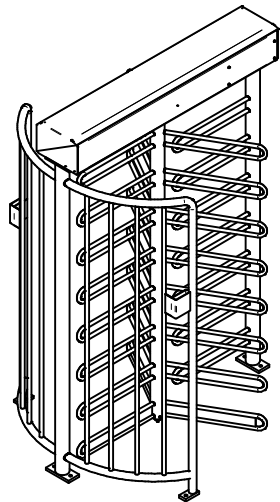
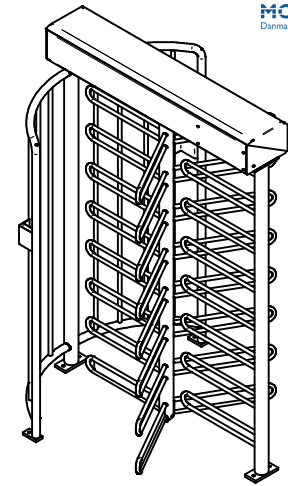
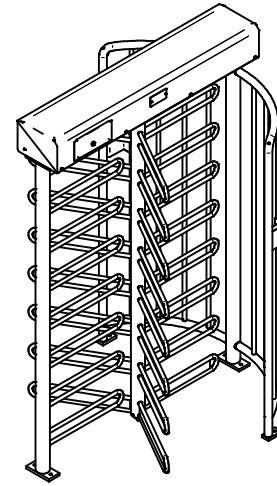
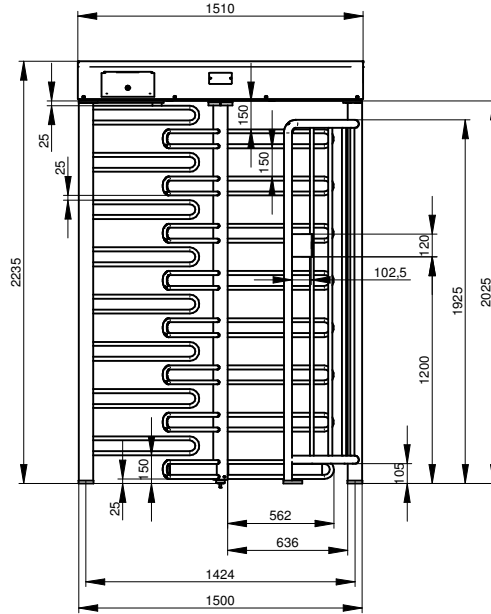
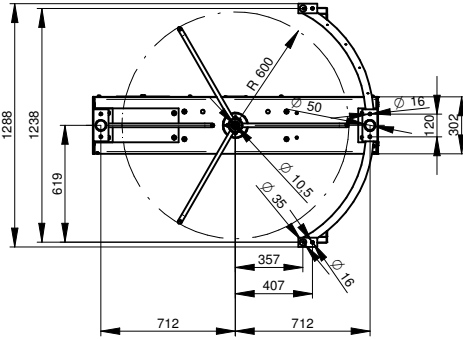

Pls. Note: This drawing is provided for information only. It is not intended for manufacturing. The user is responsible for the correct use of the drawing. The drawing is provided according to the standard ISO 10110-1:2008. The drawing is provided for information only. It is not intended for manufacturing. The user is responsible for the correct use of the drawing. The drawing is provided according to the standard ISO 10110-1:2008.

08					Halbz. Semi-Fin.Pr				
07					Maße Dimension				
06					Norm Standard				
05					Werkstoff Material				
04					Teile-Nr Part.No				
03	7E09623	21.12.09	KF		Gewicht Weight				
02	17E08537	21.01.09	KF		Passung Fit	Abmaß tolerance			
01	47E08537	02.09.08	KF						
	And. Rev.	Dat.	Name						
	bearb. Edited								
	gepr. Prov.:	16.04.04	KF						
	freig. Rel.:								

Maßbild MPT3 3x120° dimensional drawing			
5517,5037		MPT3	
Projekt-Nr / Project No 7E04504			
Festigkeit / Strength		Maßstab / Scale 1:20	
Toleranz / Tolerance		DIN A2	
MOBILHEGN.DK Danmarks billigste møbelfabrik - med garanti!			